



# PREFEITURA DE MARIALVA

Estado do Paraná - 76.282.680/0001-45

Rua Santa Efigênia, 680 Centro (44) 3232-8383 - CEP 86990-000

## NOTA DE EMPENHO

Nº do Empenho: **5069 / 2019** Ordinário Data: **30/05/2019** Página 1 / 1

Credor: 101208 BARRACHARIA DO CARNEIRO LTDA  
Endereço: Comercial: AV. PADRE THEO HERMANN, 93 - - C.E.P. 86990000 - Marialva - PR  
C.N.P.J.: 12.875.187/0001-56 Insc. Est.:  
Banco:748 - BANCO COOPERATIVO SICREDI S.A. - BANSICREDI Ag.:0723- Conta:61196-4

Orgão: 06. SECRETARIA MUN. DE INFRA-ESTRUTURA, OBRAS E SERVIÇOS	Tipo de Licitação: Pregão Nº Licitação.....: 47/2018 Nº NAD.....: 5167 Nº Convênio: /
Unidade: 06.003. DEPARTAMENTO DE TRANSPORTES	
Prog. Trabalho: 26.782.0021.2.042.MANUTENÇÃO E CONTROLE DA FROTA MECANIZADA	
Elemento Desp.: 3.3.9.0.39.00.00. OUTROS SERVIÇOS DE TERCEIROS - PESSOA JURÍDICA	
Reduzido: 251	
F. de Recurso: 1000 RECURSOS ORDINÁRIOS (LIVRES) - EXERCÍCIO CORRENT 01000	
Desdobramento: 19 99 OUTROS SERVIÇOS DE MANUTENÇÃO E CONSERVAÇÃO DE V	

<b>Dotação Inicial</b> 525.000,00	<b>Saldo Anterior</b> 261.764,61	<b>Valor</b> 1.922,00	<b>Saldo Atual</b> 259.842,61
--------------------------------------	-------------------------------------	--------------------------	----------------------------------

**HISTÓRICO:** Contratação de empresa para prestação de serviço de manutenção, concerto e socorro móvel para máquinas e veículos pesados destinados as Secretarias e Departamentos desta Municipalidade

ITEM	QTD	UN	ESPECIFICAÇÃO	VLR. UNITÁRIO	VLR. TOTAL
1	9,00	UNI	CONCERTO DE PNEUS DE VEÍCULOS PESADOS (ÔNIBUS/CAMINHÕES)	28,00	252,00
2	9,00	UNI	MONTAGEM E DESMONTAGEM DE PNEUS DE VEÍCULOS PESADOS (ÔNIBUS/CAMINHÕES)	25,00	225,00
3	17,00	UNI	CONCERTO DE PNEUS DE MÁQUINAS PESADAS (PÁ/RETRO/NIVELADORA/BOBCAT/TRATOR/ETC)	85,00	1.445,00

Local de Entrega	Total Retenções:	0,00	Total Liq. Empenho:	1.922,00
------------------	------------------	------	---------------------	----------

Empenhado por: Paulo César Mori

Autorizo a Despesa Acima Discriminada  
Marialva, de de

**PAGAMENTO** **ORDEM DE PAGAMENTO**  
Pague-se ao favorecido o valor acima especificado, proveniente, desta nota de empenho.  
Marialva, de de

VICTOR CELSO MARTINI  
Prefeito Municipal

Banco  
Nº da Conta  
Nº do Cheque

ELTON JONES CAPARROZ  
Contador CRC/PR Nº 050753/O  
de Marialva  
26 JUN. 2019  
**PAGO**

**RECIBO**  
Recebi(emos) da tesouraria da PREFEITURA DE MARIALVA, a importância especificada acima em moeda corrente do país.  
Marialva, de de

Credor: BARRACHARIA DO CARNEIRO LTDA  
C.N.P.J.: 12.875.187/0001-56

**PREFEITURA MUNICIPAL DE MARIALVA**

SECRETARIA MUNICIPAL DE TRIBUTAÇÃO

## SETOR DE TRIBUTAÇÃO

SANTA EFIGÊNIA, 680 - 86990000 - CENTRO - Marialva - PR

**NFS-e Nota Fiscal de Serviços Eletrônica**

Número: 743

Dt. Emissão: 05/06/2019

Autenticidade: 756085915

Núm. do RPS: Série do RPS: Tipo do RPS: Emissão RPS:

CONSULTE A AUTENTICIDADE DESTA DOCUMENTO ACESSANDO O SITE: [www.marialva.pr.gov.br](http://www.marialva.pr.gov.br)**DADOS DO PRESTADOR DO SERVIÇO**

Insc. Municipal: 00007219 CNPJ/CPF: 12.875.187/0001-56 Regime Fiscal: Simples Nacional

Nome/Razão Social: BORRACHARIA DO CARNEIRO LTDA

Nome Fantasia: BORRACHARIA DO CARNEIRO

## Endereço:

AVENIDA PADRE THEO HERMANN, 93 - JARDIM CUSTODIO - 1ª PARTE

Município/UF: Marialva-PR

Fone/Fax: (44) 03232-9900

E-Mail: gama@contabilidadegama.com.br

Insc. Estadual:

9054047174

**DADOS DO TOMADOR DO SERVIÇO**

Insc. Municipal: 00008955 CNPJ/CPF: 76.282.680/0001-45

Insc. Estadual:

Nome/Razão Social: PREFEITURA MUNICIPAL DE MARIALVA

Endereço: RUA SANTA EFIGÊNIA, 680 - CENTRO

Município/UF: MARIALVA-PR

CEP: 86.990-000

Fone/Fax: (44) 3232-8383

E-Mail: tributos@capitaldauvafina.com.br

**DEFINIÇÃO DO SERVIÇO**

Item da Lista de Serviços da LC nº 116/03:

1404 RECAUCHUTAGEM OU REGENERACAO DE PNEUS.

CNAE:

4520006

Competência:  
6/2019Local da Prestação do Serviço:  
Marialva-PRSituação da NFS-e:  
EMITIDANatureza da Operação:  
TRIBUTAÇÃO NO MUNICÍPIO**DISCRIMINAÇÃO DO SERVIÇO**

CONTRATAÇÃO DE EMPRESA PARA PRESTAÇÃO DE SERVIÇOS DE MANUTENÇÃO, CONSERTO E SOCORRO MOVEL PARA MAQUINAS E VEICULOS PASADOS DESTINADOS AS SECRETARIAS E DEPARTAMENTOS DESTA MUNICIPALIDADE

**ITENS DO SERVIÇO**

Tributável	Descrição do Item	Quantidade	Valor Unitário	Valor Desconto	Valor Total
SIM	CONSERTO DE PNEUS DE VEICULOS PESADOS(ONIBUS/CAMINHOS)	9,00	28,00000	0,00	252,00
SIM	MONTAGEM E DESMONTAGEM DE PNEUS DE VEICULOS PESADOS(ONIBUS/CAMINHOS)	9,00	25,00000	0,00	225,00
SIM	CONSERTO DE PNEUS DE MAQUINAS PESADAS(PÁ,RETRO,NIVELADORA,BOBCAT,TRATOR,ETC)	17,00	85,00000	0,00	1.445,00

**TRIBUTOS INCIDENTES**

Tributo	Alíquota	Valor	Retido
ISSQN	2,01000	38,63000	Sim
PIS	0,17000	3,26000	Não
COFINS	0,77000	14,79000	Não
INSS	0,00000	0,00000	Não
IR	0,24000	4,61000	Não
CSLL	0,21000	4,03000	Não
CPP	2,60000	49,97000	Não
Impostos Federais	0,00000	0,00000	Não
Outras Retenções		0,00000	Não

**TOTALIZAÇÃO DO DOCUMENTO FISCAL**

Base de Cálculo do ISSQN: 1.922,00	Valor Total Descontos: 0,00	Valor Total das Deduções: 0,00	Valor Líquido da NFS-e: 1.883,37	Valor Total da NFS-e: 1.922,00
------------------------------------	-----------------------------	--------------------------------	----------------------------------	--------------------------------

NFS-E Nº

Recebemos de BORRACHARIA DO CARNEIRO LTDA, os serviços constantes nesta documento fiscal eletrônico.

743

Recebemos de BORRACHARIA DO CARNEIRO LTDA, os serviços constantes nesta documento fiscal eletrônico.

DATA: . / . / .

Assinatura: \_\_\_\_\_

**AQUISIÇÃO - de acordo com:**

- CONVITE
- TOMADA DE PREÇO
- CONCORRÊNCIA
- PREGÃO
- DISPENSA C. \_\_\_\_\_
- INEXIGIBILIDADE

Nº 87/18 DE / /

*lu*



# Borracharia do Carneiro

CONSERVO EM GERAL / PNEUS DE CARRO / MOTOCICLETAS / CAMINHÕES / MÁQUINAS AGRÍCOLAS E OUTROS



Leo  
(44) 99877-2900

Carneiro  
(44) 99963-2333

(44) 3037-1126

AVENIDA PADRE THEO HERMANN, 113 - (AO LADO DO CAMPO, SAÍDA PARA AQUIDABAN - MARIALVA - PARANÁ  
CNPJ 12.875.187/0001-56 Inscr. Est.: 90540471-74

## PRESTAÇÃO DE SERVIÇO

2115

DATA DA EMISSÃO: 25 / 05 / 19

NOME: Pref. Mica

VEÍCULO: Ônibus

SETOR: Rod

PLACA: AJA-1821

Nº 10

1 - conserto pesado  
1 - Trip Top

28,00  
55,00

2

Preço 47

TOTAL R\$

83,00

BOB CAT

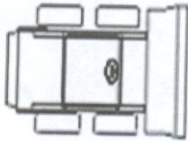

CAMINHÃO/ÔNIBUS

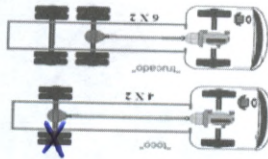

RETRO/PÁ CARREGADEIRA  
TRATOR

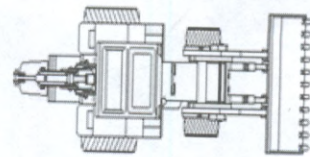

MOTO



CARRO

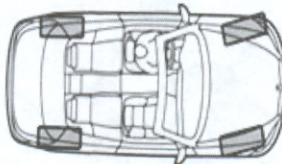

MOTONIVELADORA/PATROLA

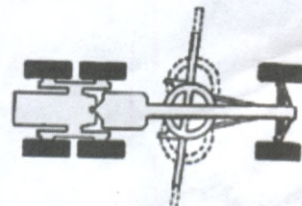

Mica Castilho  
ASSINATURA CLIENTE

[Signature]  
ASSINATURA RESPONSÁVEL

GRÁFICA ADIABINS FOMES/PR



# Borracharia do Carneiro

CONSERV. GERAL EM GERAL / PNEUS DE CARRO / MOTOCICLETAS / CAMINHÕES / MÁQUINAS AGRÍCOLAS E OUTROS

Leo  
(44) 99877-2900

Carneiro  
(44) 99963-2333

(44) 3037-1126

AVENIDA PADRE THEO HERMANN, 113 - (AO LADO DO CAMPO, SAÍDA PARA AQUIDABAN - MARIALVA - PARANÁ  
CNPJ 12.875.187/0001-56 Inscr. Est.: 90540471-74

## PRESTAÇÃO DE SERVIÇO

2101

DATA DA EMISSÃO: 20 / 05 / 19

NOME: Pref. Maria

VEÍCULO: motoniveladora

SETOR: Rod

PLACA: Nº 215

1 - montagem pronta

70,00

1 - vulcanização

150,00

2

TOTAL R\$

220,00

BOB CAT

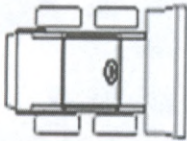

CAMINHÃO/ÔNIBUS

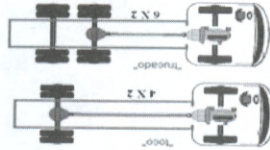

RETRO/PÁ CARREGADEIRA  
TRATOR

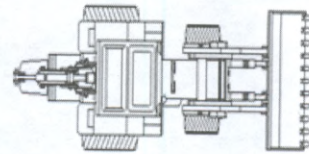

MOTO



CARRO

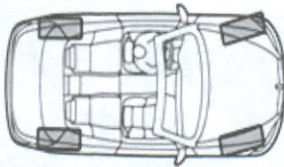

MOTONIVELADORA/PATROLA

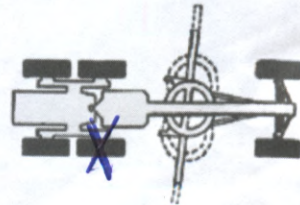

*Roberto Braga de Vito*  
ASSINATURA CLIENTE

*[Signature]*  
ASSINATURA RESPONSÁVEL



# Borracharia do Carneiro

CONSERV. EM GERAL / PNEUS DE CARRO / MOTOCICLETAS / CAMINHÕES / MÁQUINAS AGRÍCOLAS E OUTROS

Leo  
(44) 99877-2900

Carneiro  
(44) 99963-2333

(44) 3037-1126

AVENIDA PADRE THEO HERMANN, 113 - (AO LADO DO CAMPO, SAÍDA PARA AQUIDABAN - MARIALVA - PARANÁ  
CNPJ 12 875 187/0001-56 Inscr. Est.: 90540471-74

## PRESTAÇÃO DE SERVIÇO

2190

DATA DA EMISSÃO: 21 / 05 / 19

NOME: Pref. Ma

VEÍCULO: Strada SETOR: Rod

PLACA: AMR-2044 Nº 21

2 - montagem leve 26,00

Pregão 87

TOTAL R\$ 26,00

BOB CAT

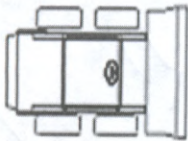

CAMINHÃO/ÔNIBUS

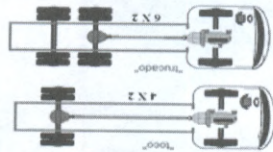

RETRO/PÁ CARREGADEIRA  
TRATOR

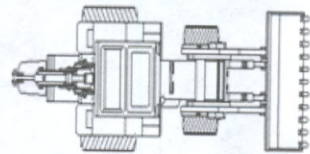

MOTO



CARRO

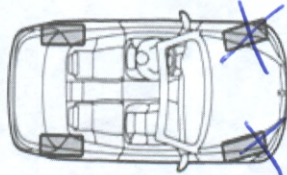

MOTONIVELADORA/PATROLA

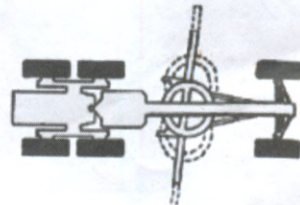

Pedro Rodrigues  
ASSINATURA CLIENTE

ASSINATURA RESPONSÁVEL



# Borracharia do Carneiro

CONSERV. GERAL / PNEUS DE CARRO / MOTOCICLETAS / CAMINHÕES / MÁQUINAS AGRÍCOLAS E OUTROS

Leão Carneiro  
(44) 99877-2900 (44) 99963-2333 (44) 3037-1126

AVENIDA PADRE THEO HERMANN, 113 - (AO LADO DO CAMPO, SAÍDA PARA AQUIDABAN - MARIALVA - PARANÁ)  
CNPJ 12.875.187/0001-56 Inscr. Est.: 90540471-74

## PRESTAÇÃO DE SERVIÇO

2189

DATA DA EMISSÃO: 20 / 05 / 19

NOME: Pref. Maria

VEÍCULO: Ret. carregadeira SETOR: Prod.

PLACA: 1. conserto pneu de mag Nº 39

85,00

Pagão 47

TOTAL R\$ 85,00

BOB CAT

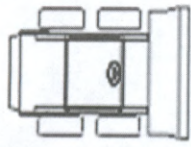

CAMINHÃO/ÔNIBUS

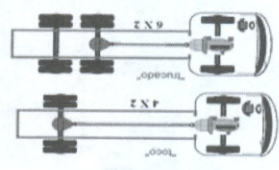

RETRO/PÁ CARREGADEIRA TRATOR

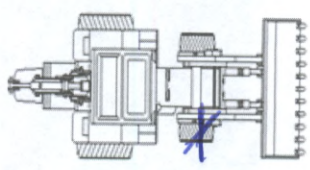

MOTO



CARRO

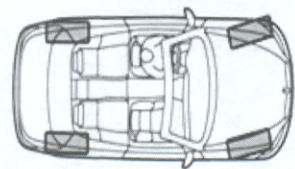

MOTONIVELADORA/PATROLA

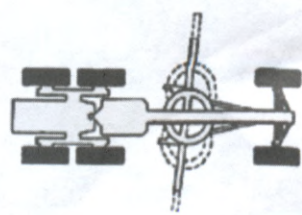

*Assinatura do cliente*

ASSINATURA CLIENTE

*Assinatura responsável*

ASSINATURA RESPONSÁVEL



# Borracharia do Carneiro

CONSERTO EM GERAL / PNEUS DE CARRO / MOTOCICLETAS / CAMINHÕES / MÁQUINAS AGRÍCOLAS E OUTROS

*Leo* (44) 99877-2900 *Carneiro* (44) 99963-2333 (44) 3037-1126

AVENIDA PADRE THEO HERMANN, 113 - (AO LADO DO CAMPO, SAÍDA PARA AQUIDABAN - MARIALVA - PARANÁ)  
CNPJ 12.875.187/0001-56 Inscr. Est.: 90540471-74

## PRESTAÇÃO DE SERVIÇO

2104

DATA DA EMISSÃO: 22 / 05 / 19



NOME: Prof. Mna

VEÍCULO: Caminhão SETOR: Pool

PLACA: AVS F 3965 Nº: 138

<u>2 - conserto pesado</u>	<u>5600</u>
<u>1 - top top</u>	<u>5500</u>
	<u>2</u>

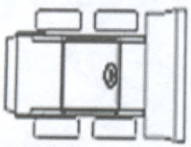
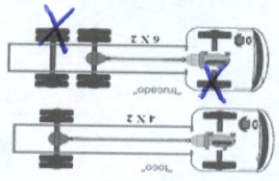
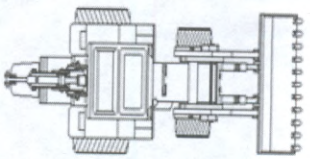
Pregão 47 TOTAL R\$ 111,00

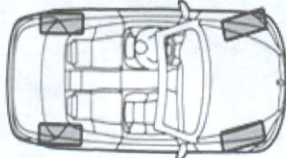
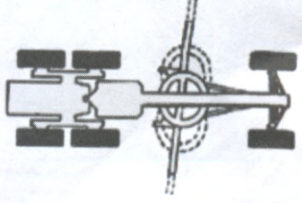
BOB CAT 	CAMINHÃO/ÔNIBUS 	RETRO/PÁ CARREGADEIRA TRATOR 
MOTO 	CARRO 	MOTONIVELADORA/PATROLA 

*Robson Carneiro* ASSINATURA CLIENTE

*[Signature]* ASSINATURA RESPONSÁVEL





# Borracharia do Carneiro

CONSERTO EM GERAL / PNEUS DE CARRO / MOTOCICLETAS / CAMINHÕES / MÁQUINAS AGRÍCOLAS E OUTROS

Leo  
(44) 99877-2900

Carneiro  
(44) 99963-2333

(44) 3037-1126

AVENIDA PADRE THEO HERMANN, 113 - (AO LADO DO CAMPO, SAÍDA PARA AQUIDABAN - MARIALVA - PARANÁ)  
CNPJ 12.875.187/0001-56 Inscr. Est.: 90540471-74

## PRESTAÇÃO DE SERVIÇO

2105

DATA DA EMISSÃO: 23 / 05 / 19

NOME: Pref. Mota

VEÍCULO: Caminhão

SETOR: Rod

PLACA: AVS-3985

Nº 138

1 - montagem pesada 2500

1 - recalibração 1500

2

Preço 47

TOTAL R\$ 1750

BOB CAT

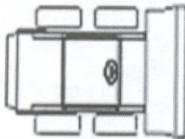

CAMINHÃO/ÔNIBUS

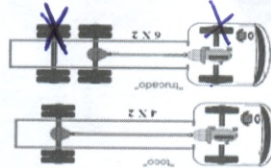

RETRO/PÁ CARREGADEIRA  
TRATOR

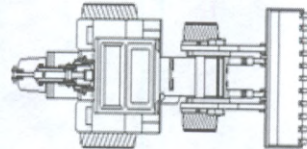

MOTO



CARRO

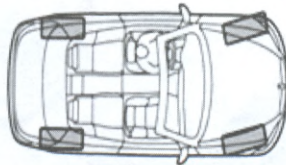

MOTONIVELADORA/PATROLA

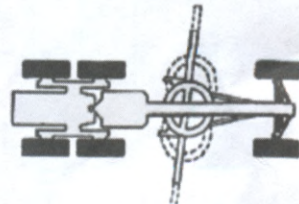

*Valdir Vecchio*

ASSINATURA CLIENTE

*[Signature]*

ASSINATURA RESPONSÁVEL



# Borracharia do Carneiro

CONSERTO EM GERAL / PNEUS DE CARRO / MOTOCICLETAS / CAMINHÕES / MÁQUINAS AGRÍCOLAS E OUTROS

Leo (44) 99877-2900

Carneiro (44) 99963-2333

(44) 3037-1126

AVENIDA PADRE THEO HERMANN, 113 - (AO LADO DO CAMPO, SAÍDA PARA AQUIDABAN - MARIALVA - PARANÁ  
CNPJ 12.875.187/0001-56 Inscr. Est.: 90540471-74

## PRESTAÇÃO DE SERVIÇO

2175

DATA DA EMISSÃO: 15 / 05 / 19

NOME: Prof. Marco

VEÍCULO: Caminhão

SETOR: Limpeza

PLACA: ART-24JM

Nº 106

2 conserto resaca 56,00

1 tip top 55,00

?

Preços 47

TOTAL R\$ 111,00

BOB CAT

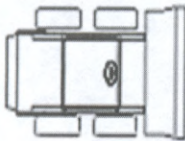

CAMINHÃO/ÔNIBUS

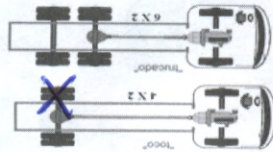

RETRO/PÁ CARREGADEIRA TRATOR

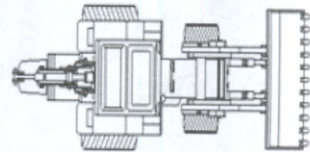

MOTO



CARRO

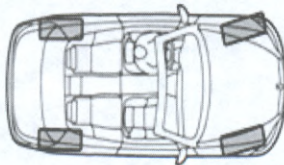

MOTONIVELADORA/PATROLA

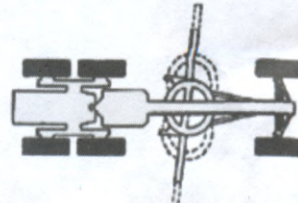

ASSINATURA CLIENTE

ASSINATURA RESPONSÁVEL

3



# Borracharia do Carneiro

CONserto em GERAL / PNEUS DE CARRO / MOTOCICLETAS / CAMINHÕES / MÁQUINAS AGRÍCOLAS E OUTROS



Leo  
(44) 99877-2900

Carneiro  
(44) 99963-2333

(44) 3037-1126

AVENIDA PADRE THEO HERMANN, 113 - (AO LADO DO CAMPO, SAÍDA PARA AQUIDABAN - MARIALVA - PARANÁ  
CNPJ 12.875.187/0001-56 Inscr. Est.: 90540471-74

## PRESTAÇÃO DE SERVIÇO

2200

DATA DA EMISSÃO:

NOME:

VEÍCULO:

PLACA:

SETOR:

Nº

13/05/19  
 Refon. de maravalh  
 Trator Rodoviário  
 Leopoldo pesada 8500  
 7 447 790 95000

Preço 47

TOTAL R\$

140,00

BOB CAT

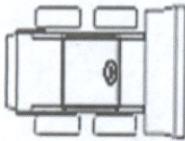

CAMINHÃO/ÔNIBUS

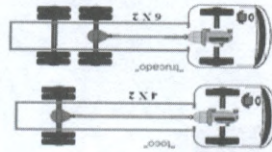

RETRO/PÁ CARREGADEIRA  
TRATOR

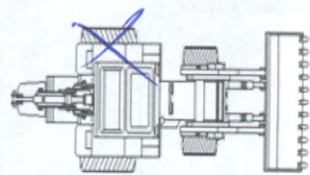

MOTO



CARRO

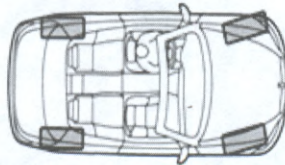

MOTONIVELADORA/PATROLA

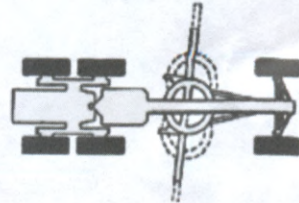

ASSINATURA CLIENTE

ASSINATURA RESPONSÁVEL

GRÁFICA AQUÁRIOS - FONES: (44) 3232-3405 - 10 BLS. - 50X2



# Borracharia do Carneiro

CONSERTO EM GERAL / PNEUS DE CARRO / MOTOCICLETAS / CAMINHÕES / MÁQUINAS AGRÍCOLAS E OUTROS

*Léo*  
(44) 99877-2900

*Carneiro*  
(44) 99963-2333

(44) 3037-1126

AVENIDA PADRE THEO HERMANN, 113 - (AO LADO DO CAMPO, SAÍDA PARA AQUIDABAN - MARIALVA - PARANÁ  
CNPJ 12.875.187/0001-56 Inscr. Est.: 90540471-74

## PRESTAÇÃO DE SERVIÇO

2196

DATA DA EMISSÃO: 17/05/19

NOME: Paulo de Maria

VEÍCULO: Traca SETOR: Padaria

PLACA: 1 montagem Perodo Nº: 79

1. Manutenção 1. Furo

1. Manutenção 1.900,00

1.900,00

Reparo 47.

TOTAL R\$ 22000

BOB CAT

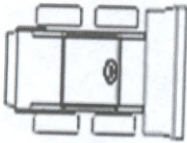

CAMINHÃO/ÔNIBUS

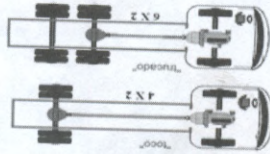

RETRO/PÁ CARREGADEIRA TRATOR

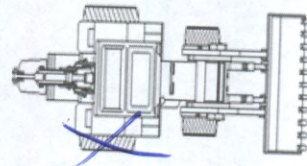

MOTO



CARRO

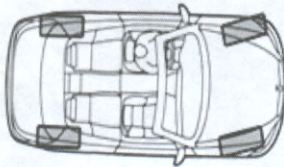

MOTONIVELADORA/PATROLA

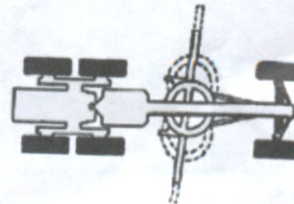

ASSINATURA CLIENTE

ASSINATURA RESPONSÁVEL

GRÁFICA AQUÁRIOS - FONES: (44) 3222-2400

3



# Borracharia do Carneiro

CONSERTO EM GERAL / PNEUS DE CARRO / MOTOCICLETAS / CAMINHÕES / MÁQUINAS AGRÍCOLAS E OUTROS



Leo  
(44) 99877-2900

Carneiro  
(44) 99963-2333

(44) 3037-1126

AVENIDA PADRE THEO HERMANN, 113 - (AO LADO DO CAMPO, SAÍDA PARA AQUIDABAN - MARIALVA - PARANÁ  
CNPJ 12 875 187/0001-56 Inscr. Est.: 90540471-74

## PRESTAÇÃO DE SERVIÇO

2186

DATA DA EMISSÃO: 16 / 05 / 19

NOME: Pref. msc

VEÍCULO: motoniveladora

SETOR: Rod

PLACA: \_\_\_\_\_

Nº 166

1 - conserto pesado mag 85,00

?

Pagão 47

TOTAL R\$ 85,00

BOB CAT

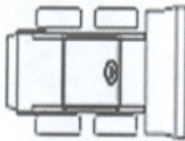

CAMINHÃO/ÔNIBUS

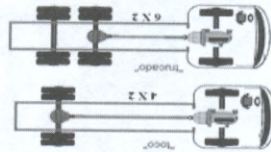

RETRO/PÁ CARREGADEIRA  
TRATOR

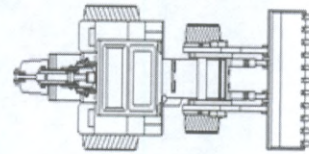

MOTO



CARRO

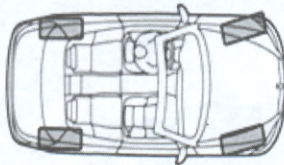

MOTONIVELADORA/PATROLA

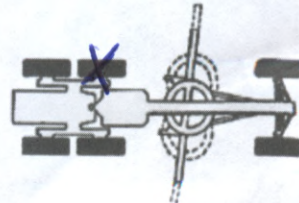

*Gratiano & outros*  
ASSINATURA CLIENTE

*[Signature]*  
ASSINATURA RESPONSÁVEL



# Borracharia do Carneiro

CONSERTO EM GERAL / PNEUS DE CARRO / MOTOCICLETAS / CAMINHÕES / MÁQUINAS AGRÍCOLAS E OUTROS

Leão (44) 99877-2900

Carneiro (44) 99963-2333

(44) 3037-1126

AVENIDA PADRE THEO HERMANN, 113 - (AO LADO DO CAMPO, SAÍDA PARA AQUIDABAN - MARIALVA - PARANÁ)  
CNPJ 12.875.187/0001-56 Inscr. Est.: 90540471-74

## PRESTAÇÃO DE SERVIÇO

2181

DATA DA EMISSÃO:

16.05.19

NOME:

Reparação de maquiagem

VEÍCULO:

A. Carregadeira Rodoviária

SETOR:

PLACA:

1 mara... Nº 106

1 maquiagem	pesado mag	70,00
1 vauca... e		50,00
		2

Preço 42

TOTAL R\$

220,00

BOB CAT

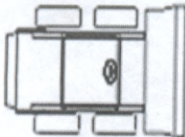

CAMINHÃO/ÔNIBUS

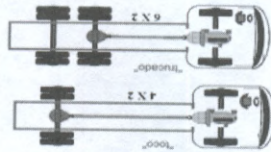

RETRO/PÁ CARREGADEIRA TRATOR

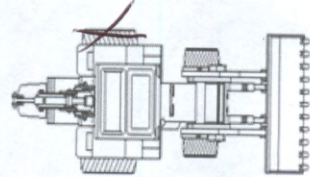

MOTO



CARRO

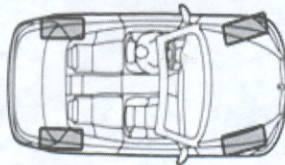

MOTONIVELADORA/PATROLA

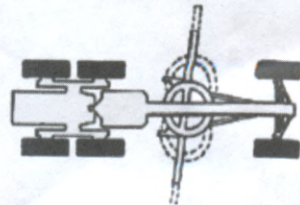

*Qualite Sovero*

ASSINATURA CLIENTE

ASSINATURA RESPONSÁVEL

GRÁFICA AQUÁRIOS - FONES: (44) 3232-3400 - 40 BIS - FVPS

3



# Borracharia do Carneiro

CONSERTO EM GERAL / PNEUS DE CARRO / MOTOCICLETAS / CAMINHÕES / MÁQUINAS AGRÍCOLAS E OUTROS



Leo  
(44) 99877-2900

Carneiro  
(44) 99963-2333

(44) 3037-1126

AVENIDA PADRE THEO HERMANN, 113 - (AO LADO DO CAMPO, SAÍDA PARA AQUIDABAN - MARIALVA - PARANÁ  
CNPJ 12.875.187/0001-56 Inscr. Est.: 90540471-74

## PRESTAÇÃO DE SERVIÇO

2176

DATA DA EMISSÃO: 15 / 05 / 19

NOME: Prof. Maria

VEÍCULO: Caminhão

SETOR: Rod

PLACA: AVS-3965

Nº 138

1 conserto. pesado  
1 vulcanização

28,00

159,00

Preço 47

TOTAL R\$

178,00

BOB CAT

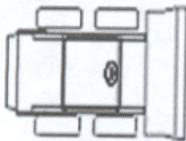

CAMINHÃO/ÔNIBUS

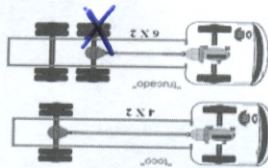

RETRO/PÁ CARREGADEIRA  
TRATOR

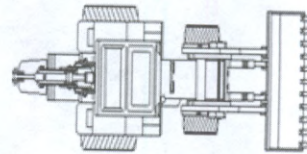

MOTO



CARRO

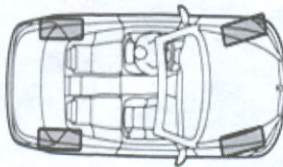

MOTONIVELADORA/PATROLA

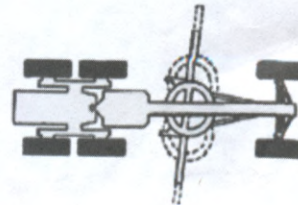

*Valdinei Carneiro*

ASSINATURA CLIENTE

ASSINATURA RESPONSÁVEL

3

# Borracharia do Carneiro

CONSERTO EM GERAL / PNEUS DE CARRO / MOTOCICLETAS / CAMINHÕES / MÁQUINAS AGRÍCOLAS E OUTROS



Leo  
(44) 99877-2900

Carneiro  
(44) 99963-2333

(44) 3037-1126

AVENIDA PADRE THEO HERMANN, 113 - (AO LADO DO CAMPO, SAÍDA PARA AQUIDABAN - MARIALVA - PARANÁ  
CNPJ 12 875 187/0001-56 Inscr. Est.: 90540471-74

## PRESTAÇÃO DE SERVIÇO

2102

DATA DA EMISSÃO: 14 / 05 / 19

NOME: Prof. Maria

VEÍCULO: motoniveladora

SETOR: Rural

PLACA: \_\_\_\_\_

Nº 205

J. cons. pesado mag \_\_\_\_\_ 85,00

TOTAL R\$

85,00

BOB CAT

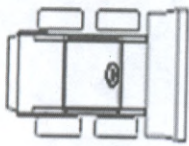

CAMINHÃO/ÔNIBUS

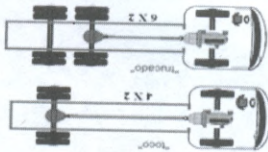

RETRO/PÁ CARREGADEIRA  
TRATOR

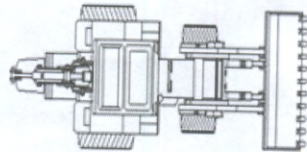

MOTO



CARRO

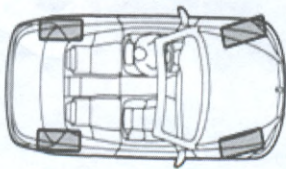

MOTONIVELADORA/PATROLA

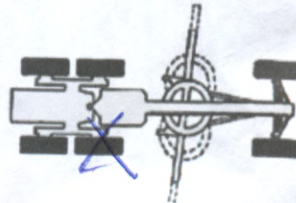

Prof. Maria  
ASSINATURA CLIENTE

ASSINATURA RESPONSÁVEL

GRÁFICA AQUÁRIOS - FONES: (44) 3232-3405 - 40818 - 5000



3



# Borracharia do Carneiro

CONSERTO EM GERAL / PNEUS DE CARRO / MOTOCICLETAS / CAMINHÕES / MÁQUINAS AGRÍCOLAS E OUTROS

Leo (44) 99877-2900

Carneiro (44) 99963-2333

(44) 3037-1126

AVENIDA PADRE THEO HERMANN, 113 - (AO LADO DO CAMPO, SAÍDA PARA AQUIDABAN - MARIALVA - PARANÁ  
CNPJ 12 875 187/0001-56 Inscr. Est.: 90540471-74

## PRESTAÇÃO DE SERVIÇO

2174

DATA DA EMISSÃO: 14 / 05 / 19

NOME: Prof. Wma

VEÍCULO: Trator

SETOR: Culinar

PLACA:

1- conserto pesado mag

Nº 8500

2

Preço 47

TOTAL R\$

8500

BOB CAT

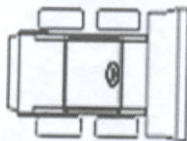

CAMINHÃO/ÔNIBUS

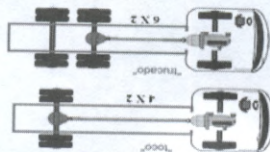

RETRO/PÁ CARREGADEIRA TRATOR

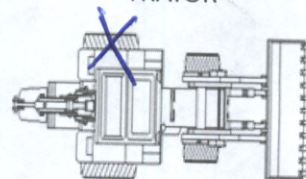

MOTO



CARRO

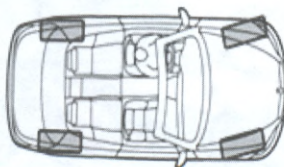

MOTONIVELADORA/PATROLA

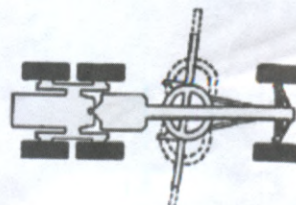

ASSINATURA CLIENTE

ASSINATURA RESPONSÁVEL



# Borracharia do Carneiro

CONSERTO EM GERAL / PNEUS DE CARRO / MOTOCICLETAS / CAMINHÕES / MÁQUINAS AGRÍCOLAS E OUTROS



Leo  
(44) 99877-2900

Carneiro  
(44) 99963-2333

(44) 3037-1126

AVENIDA PADRE THEO HERMANN, 113 - (AO LADO DO CAMPO, SAÍDA PARA AQUIDABAN - MARIALVA - PARANÁ)  
CNPJ 12.875.187/0001-56 Inscr. Est.: 90540471-74

## PRESTAÇÃO DE SERVIÇO

2153

DATA DA EMISSÃO: 09 / 05 / 19

NOME: *Pref. mra*

VEÍCULO: *Trator*

SETOR: *Limpeza*

PLACA: \_\_\_\_\_

Nº *168*

<i>1. conserto parafuso mag</i>	<i>85,00</i>
<i>2. tip top</i>	<i>55,00</i>
	<i>?</i>

*Preço 47*

TOTAL R\$

*140,00*

BOB CAT

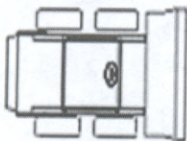

CAMINHÃO/ÔNIBUS

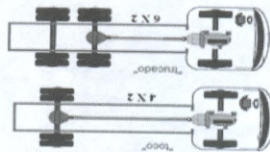

RETRO/PÁ CARREGADEIRA  
TRATOR

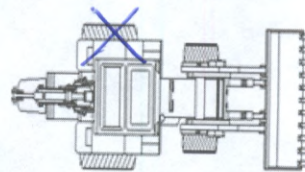

MOTO



CARRO

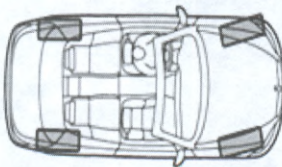

MOTONIVELADORA/PATROLA

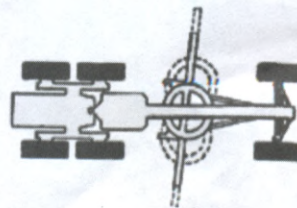

*[Handwritten Signature]*

ASSINATURA CLIENTE

*[Handwritten Signature]*

ASSINATURA RESPONSÁVEL



# Borracharia do Carneiro

CONSERTO EM GERAL / PNEUS DE CARRO / MOTOCICLETAS / CAMINHÕES / MÁQUINAS AGRÍCOLAS E OUTROS



*Léo*  
(44) 99877-2900

*Carneiro*  
(44) 99963-2333

(44) 3037-1126

AVENIDA PADRE THEO HERMANN, 113 - (AO LADO DO CAMPO, SAÍDA PARA AQUIDABAN - MARIALVA - PARANÁ)  
CNPJ 12 875 187/0001-56 Inscr. Est.: 90540471-74

## PRESTAÇÃO DE SERVIÇO

2239

DATA DA EMISSÃO: 07/05/19

NOME: Prof. Mica

VEÍCULO: Retroescavadeira

SETOR: Rod

PLACA: \_\_\_\_\_ Nº 47

4. conserto pesado mag 340,00

Pagão 47

TOTAL R\$ 340,00

BOB CAT

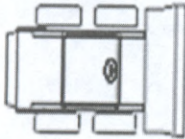

CAMINHÃO/ÔNIBUS

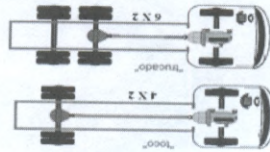

RETRO/PÁ CARREGADEIRA  
TRATOR

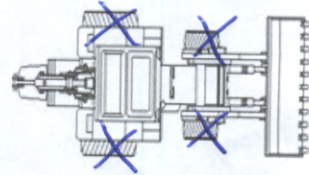

MOTO



CARRO

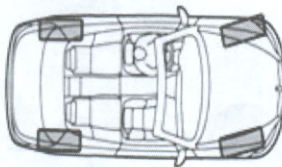

MOTONIVELADORA/PATROLA

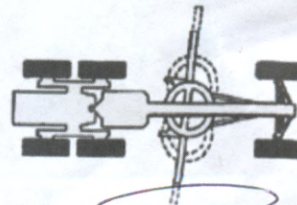

Milton Santos de Silva

ASSINATURA CLIENTE

ASSINATURA RESPONSÁVEL



# Borracharia do Carneiro

CONserto EM GERAL / PNEUS DE CARRO / MOTOCICLETAS / CAMINHÕES / MÁQUINAS AGRÍCOLAS E OUTROS



Leo  
(44) 99877-2900

Carneiro  
(44) 99963-2333

(44) 3037-1126

AVENIDA PADRE THEO HERMANN, 113 - (AO LADO DO CAMPO, SAÍDA PARA AQUIDABAN - MARIALVA - PARANÁ)  
CNPJ 12.875.187/0001-56 Inscr. Est.: 90540471-74

## PRESTAÇÃO DE SERVIÇO

2234

DATA DA EMISSÃO: 06 / 05 / 19

NOME: Pref. Maria

VEÍCULO: Caminhão

SETOR: Rod

PLACA: AYM-1361

Nº 165

1 - montagem pesada 25,00

Pagão 47

TOTAL R\$ 25,00

BOB CAT

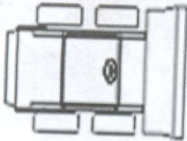

CAMINHÃO/ÔNIBUS

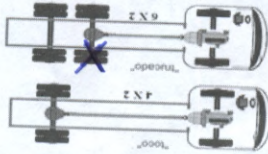

RETRO/PÁ CARREGADEIRA  
TRATOR

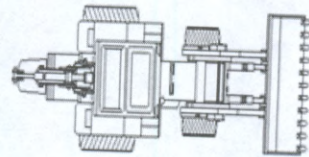

MOTO



CARRO

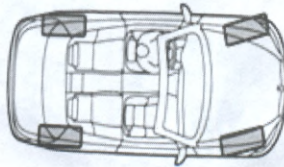

MOTONIVELADORA/PATROLA

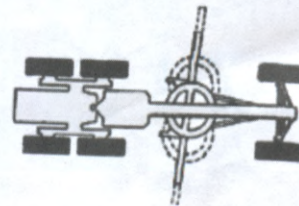

Osvaldo U Filho  
ASSINATURA CLIENTE

ASSINATURA RESPONSÁVEL



# Borracharia do Carneiro

CONSERTO EM GERAL / PNEUS DE CARRO / MOTOCICLETAS / CAMINHÕES / MÁQUINAS AGRÍCOLAS E OUTROS



Leo  
(44) 99877-2900

Carneiro  
(44) 99963-2333

(44) 3037-1126

AVENIDA PADRE THEO HERMANN, 113 - (AO LADO DO CAMPO, SAÍDA PARA AQUIDABAN - MARIALVA - PARANÁ  
CNPJ 12.875.187/0001-56 Inscr. Est.: 90540471-74

## PRESTAÇÃO DE SERVIÇO

2243

DATA DA EMISSÃO: 07 / 05 / 19

NOME: Pref. Mva

VEÍCULO: Kombi

SETOR: Rod

PLACA: ALR-5584

Nº 87

2 conserto leve

3900

Pregos 87

TOTAL R\$

3900

BOB CAT

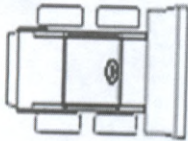

CAMINHÃO/ÔNIBUS

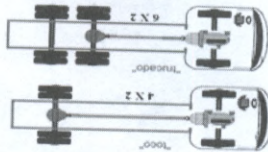

RETRO/PÁ CARREGADEIRA  
TRATOR

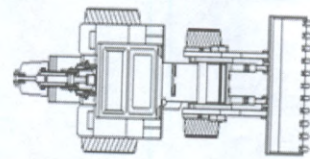

MOTO



CARRO

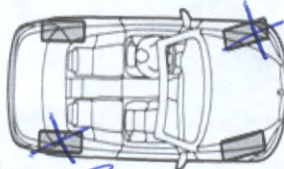

MOTONIVELADORA/PATROLA

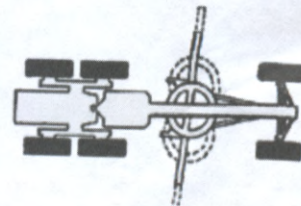

*[Handwritten signature]*  
ASSINATURA CLIENTE

*[Handwritten signature]*  
ASSINATURA RESPONSÁVEL



# Borracharia do Carneiro

CONSERVO EM GERAL / PNEUS DE CARRO / MOTOCICLETAS / CAMINHÕES / MÁQUINAS AGRÍCOLAS E OUTROS



Leo  
(44) 99877-2900

Carneiro  
(44) 99963-2333

(44) 3037-1126

AVENIDA PADRE THEO HERMANN, 113 - (AO LADO DO CAMPO, SAÍDA PARA AQUIDABAN - MARIALVA - PARANÁ)  
CNPJ 12 875 187/0001-56 Inscr. Est.: 90540471-74

## PRESTAÇÃO DE SERVIÇO

2244

DATA DA EMISSÃO: 07 / 05 / 19

NOME: Pref. Mma

VEÍCULO: Caminhão SETOR: Rod

PLACA: AVS-4027 Nº 137

1 cimento pesado 28,00

1 lip top 55,00

Pregão 47

TOTAL R\$ 83,00

BOB CAT

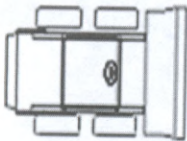

CAMINHÃO/ÔNIBUS

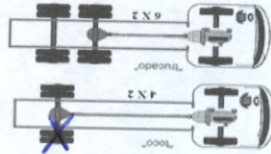

RETRO/PÁ CARREGADEIRA TRATOR

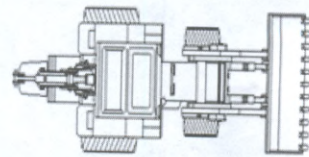

MOTO



CARRO

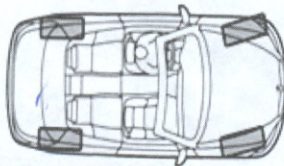

MOTONIVELADORA/PATROLA

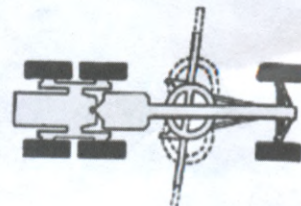

ASSINATURA CLIENTE

ASSINATURA RESPONSÁVEL

2



# Borracharia do Carneiro

CONSERTO EM GERAL / PNEUS DE CARRO / MOTOCICLETAS / CAMINHÕES / MÁQUINAS AGRÍCOLAS E OUTROS



Leo  
(44) 99877-2900

Carneiro  
(44) 99963-2333

(44) 3037-1126

AVENIDA PADRE THEO HERMANN, 113 - (AO LADO DO CAMPO, SAÍDA PARA AQUIDABAN - MARIALVA - PARANÁ  
CNPJ 12 875 187/0001-56 Inscr. Est.: 90540471-74

## PRESTAÇÃO DE SERVIÇO

2199

DATA DA EMISSÃO:

10 / 5 / 19

NOME:

Paulo de morato

VEÍCULO:

Camionete

SETOR:

Borracharia

PLACA:

APM-1361

Nº

265

1 manutenção pesada  
1 substituição

2500  
1500

Reparo 47

TOTAL R\$

17500

BOB CAT

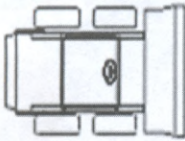

CAMINHÃO/ÔNIBUS

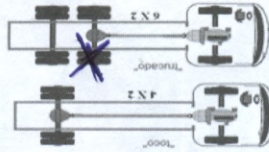

RETRO/PÁ CARREGADEIRA  
TRATOR

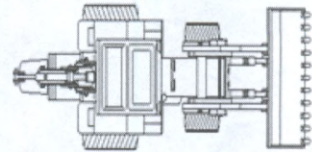

MOTO



CARRO

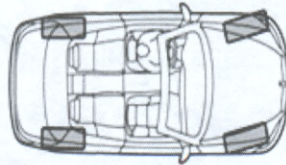

MOTONIVELADORA/PATROLA

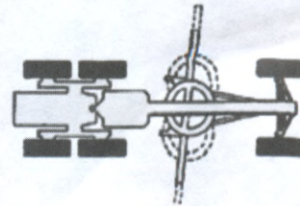

ASSINATURA CLIENTE

ASSINATURA RESPONSÁVEL

GRÁFICA AQUÁRIOS - FONES: (44) 3232-3405 - 10 BLS. - 50X2



# Borracharia do Carneiro

CONSERTO EM GERAL / PNEUS DE CARRO / MOTOCICLETAS / CAMINHÕES / MÁQUINAS AGRÍCOLAS E OUTROS

Leão (44) 99877-2900

Carneiro (44) 99963-2333

(44) 3037-1126

AVENIDA PADRE THEO HERMANN, 113 - (AO LADO DO CAMPO, SAÍDA PARA AQUIDABAN - MARIALVA - PARANÁ  
CNPJ 12 875 187/0001-56 Inscr. Est.: 90540471-74

## PRESTAÇÃO DE SERVIÇO

2197

DATA DA EMISSÃO:

NOME:

VEÍCULO:

SETOR:

PLACA:

12/07/19  
 Pneu de máquina  
 Trator  
 SETOR: Borracharia  
 1 manutenção pesada Nº 282  
 1 alinhamento 15000  
 Pneu 47  
 TOTAL R\$ 2200

BOB CAT

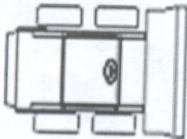

CAMINHÃO/ÔNIBUS

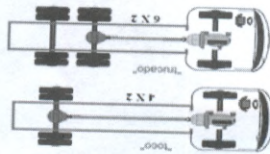

RETRO/PÁ CARREGADEIRA  
TRATOR

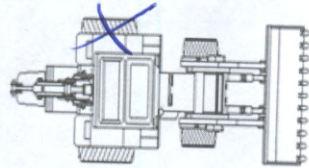

MOTO



CARRO

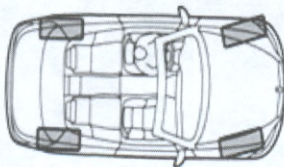

MOTONIVELADORA/PATROLA

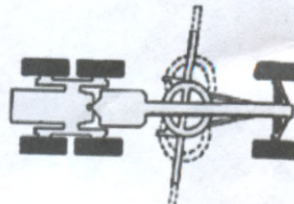

ASSINATURA CLIENTE

ASSINATURA RESPONSÁVEL

GRÁFICA AQUÁRIOS - FONES: (44) 3232-3405 - 10 P. S. 6000





# Borracharia do Carneiro

CONSERVO EM GERÁL / PNEUS DE CARRO / MOTOCICLETAS / CAMINHÕES / MÁQUINAS AGRÍCOLAS E OUTROS

*Leão* (44) 99877-2900 *Carneiro* (44) 99963-2333 (44) 3037-1126

AVENIDA PADRE THEO HERMANN, 113 - (AO LADO DO CAMPO, SAÍDA PARA AQUIDABAN - MARIALVA - PARANÁ  
CNPJ 12 875 187/0001-56 Inscr. Est.: 90540471-74

## PRESTAÇÃO DE SERVIÇO

2158

DATA DA EMISSÃO: 6 / 5 / 19

NOME: Rubem de Maria

VEÍCULO: Mercedes

SETOR: Agr.

PLACA: Mantiga Roda

Nº 196

Manutenção Roda - 7000  
Vaucação - 15000

Pagto 47

TOTAL R\$ 22000

BOB CAT

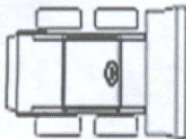

CAMINHÃO/ÔNIBUS

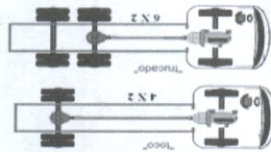

RETRO/PÁ CARREGADEIRA  
TRATOR

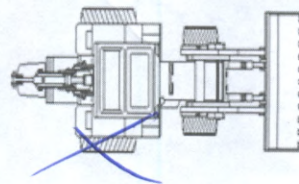

MOTO



CARRO

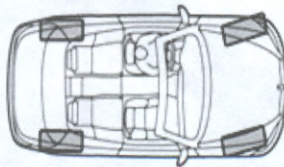

MOTONIVELADORA/PATROLA

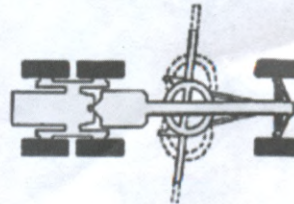

ASSINATURA CLIENTE

ASSINATURA RESPONSÁVEL



# Borracharia do Carneiro

CONSERVO EM GERAL / PNEUS DE CARRO / MOTOCICLETAS / CAMINHÕES / MÁQUINAS AGRÍCOLAS E OUTROS

Leo Carneiro  
(44) 99877-2900 (44) 99963-2333 (44) 3037-1126

AVENIDA PADRE THEO HERMANN, 113 - (AO LADO DO CAMPO, SAÍDA PARA AQUIDABAN - MARIALVA - PARANÁ)  
CNPJ 12.875.187/0001-56 Inscr. Est.: 90540471-74

## PRESTAÇÃO DE SERVIÇO

2245

DATA DA EMISSÃO: 07 / 05 / 19

NOME: Pres. MHA

VEÍCULO: motocicleta SETOR: Rod

PLACA: \_\_\_\_\_ Nº 146

<u>1 - conserto peças de mag</u>	<u>8500</u>
<u>1 - tip top</u>	<u>5900</u>
	<u>2</u>

Pagão 47 TOTAL R\$ 14900

BOB CAT

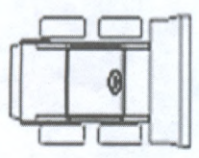

CAMINHÃO/ÔNIBUS

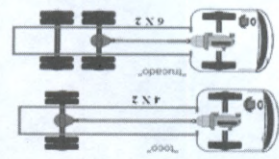

RETRO/PÁ CARREGADEIRA TRATOR

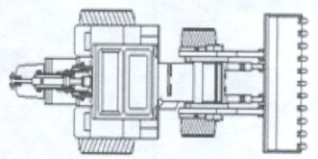

MOTO



CARRO

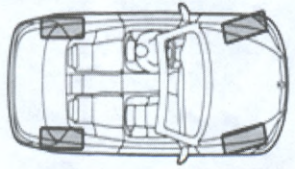

MOTONIVELADORA/PATROLA

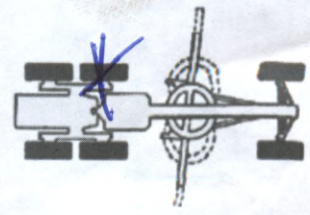

\_\_\_\_\_  
ASSINATURA CLIENTE

\_\_\_\_\_  
ASSINATURA RESPONSÁVEL

2



# Borracharia do Carneiro

CONSERVO EM GERAL / PNEUS DE CARRO / MOTOCICLETAS / CAMINHÕES / MÁQUINAS AGRÍCOLAS E OUTROS



*Leo*  
(44) 99877-2900

*Carneiro*  
(44) 99963-2333

(44) 3037-1126

AVENIDA PADRE THEO HERMANN, 113 - (AO LADO DO CAMPO, SAÍDA PARA AQUIDABAN - MARIALVA - PARANÁ  
CNPJ 12 875 187/0001-56 Inscr. Est.: 90540471-74

## PRESTAÇÃO DE SERVIÇO

2157

DATA DA EMISSÃO:

*07/05/19*

NOME:

*Wesley de Melo*

VEÍCULO:

*Trator carregador* SETOR: *Agropecuária*

PLACA:

*consel. operador m. q. n.º 166*

*consel. operador m. q. n.º 8500*  
*Waucaçanga 1: 15000*

*Pneus 47*

TOTAL R\$

*23500*

BOB CAT

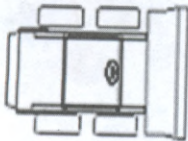

CAMINHÃO/ÔNIBUS

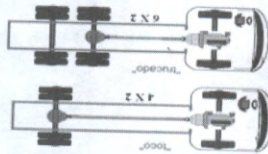

RETRO/PÁ CARREGADEIRA  
TRATOR

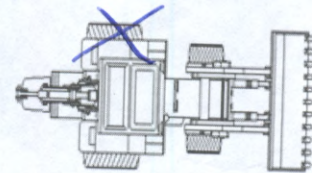

MOTO



CARRO

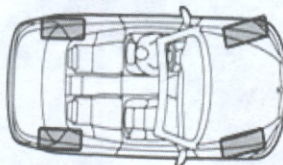

MOTONIVELADORA/PATROLA

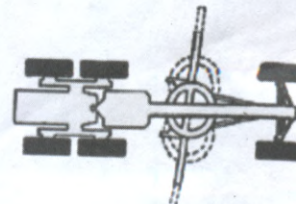

*Wesley de Melo*

ASSINATURA CLIENTE

*[Signature]*

ASSINATURA RESPONSÁVEL

GRÁFICA AQUÁRIOS - FONES: (41) 3333-XXXX



# Borracharia do Carneiro

CONSERTEO EM GERAL / PNEUS DE CARRO / MOTOCICLETAS / CAMINHÕES / MÁQUINAS AGRÍCOLAS E OUTROS



Leo  
(44) 99877-2900

Carneiro  
(44) 99963-2333

(44) 3037-1126

AVENIDA PADRE THEO HERMANN, 113 - (AO LADO DO CAMPO, SAÍDA PARA AQUIDABAN - MARIALVA - PARANÁ)  
CNPJ 12 875 187/0001-56 Inscr. Est.: 90540471-74

## PRESTAÇÃO DE SERVIÇO

2163

DATA DA EMISSÃO: 10 / 05 / 19

NOME: Prof. Inna

VEÍCULO: Caminhão SETOR: Road

PLACA: AYM-1361 Nº 165

2 montagem pesada 59,00

Pagão 47

TOTAL R\$

59,00

BOB CAT

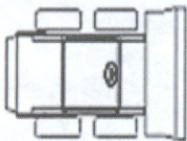

CAMINHÃO/ÔNIBUS

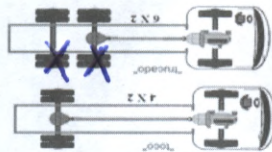

RETRO/PÁ CARREGADEIRA  
TRATOR

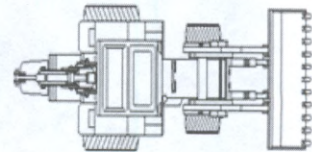

MOTO



CARRO

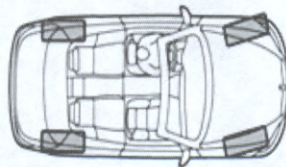

MOTONIVELADORA/PATROLA

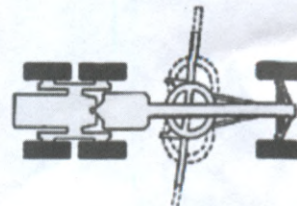

Orlando e Filho  
ASSINATURA CLIENTE

ASSINATURA RESPONSÁVEL



# Borracharia do Carneiro

CONSERÇO EM GERAL / PNEUS DE CARRO / MOTOCICLETAS / CAMINHÕES / MÁQUINAS AGRÍCOLAS E OUTROS



Leo  
(44) 99877-2900

Carneiro  
(44) 99963-2333

(44) 3037-1126

AVENIDA PADRE THEO HERMANN, 113 - (AO LADO DO CAMPO, SAÍDA PARA AQUIDABAN - MARIALVA - PARANÁ)  
CNPJ 12.875.187/0001-56 Inscr. Est.: 90540471-74

## PRESTAÇÃO DE SERVIÇO

2166

DATA DA EMISSÃO: 10 / 05 / 19

NOME: Pref. Maria

VEÍCULO: Caminhão

SETOR: Rod

PLACA: AVS-4027

Nº 137

3 montagem pneu 75,00

Preço 47

TOTAL R\$

75,00

BOB CAT

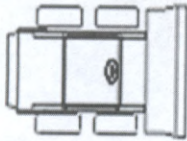

CAMINHÃO/ÔNIBUS

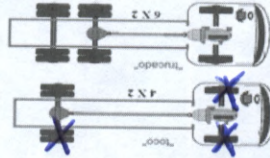

RETRO/PÁ CARREGADEIRA  
TRATOR

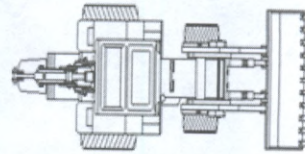

MOTO



CARRO

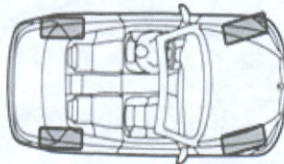

MOTONIVELADORA/PATROLA

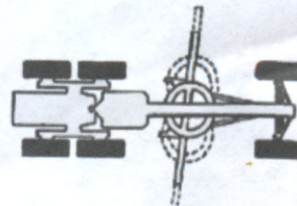

ASSINATURA CLIENTE

ASSINATURA RESPONSÁVEL



# Borracharia do Carneiro

CONSERÇO EM GERAL / PNEUS DE CARRO / MOTOCICLETAS / CAMINHÕES / MÁQUINAS AGRÍCOLAS E OUTROS



Leo  
(44) 99877-2900

Carneiro  
(44) 99963-2333

(44) 3037-1126

AVENIDA PADRE THEO HERMANN, 113 - (AO LADO DO CAMPO, SAÍDA PARA AQUIDABAN - MARIALVA - PARANÁ)  
CNPJ 12 875 187/0001-56 Inscr. Est.: 90540471-74

## PRESTAÇÃO DE SERVIÇO

2165

DATA DA EMISSÃO: 10 / 05 / 19

NOME: *Prof. Maria*

VEÍCULO: *Motocicleta*

SETOR: *Road*

PLACA: \_\_\_\_\_ Nº *146*

<i>1. conserto passageiro</i>	<i>85,00</i>
<i>2. tip top</i>	<i>55,00</i>
	<i>2</i>

*Pagão 47*

TOTAL R\$ *149,00*

BOB CAT

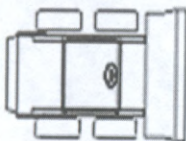

CAMINHÃO/ÔNIBUS

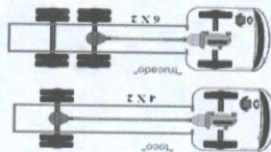

RETRO/PÁ CARREGADEIRA  
TRATOR

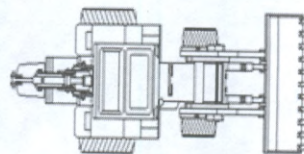

MOTO



CARRO

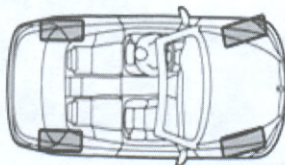

MOTONIVELADORA/PATROLA

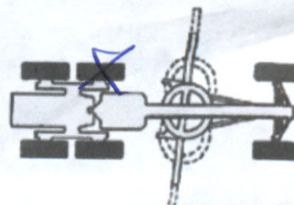

*Senilto Mui*

ASSINATURA CLIENTE

*[Signature]*

ASSINATURA RESPONSÁVEL



# Borracharia do Carneiro

CONSERTO EM GERAL / PNEUS DE CARRO / MOTOCICLETAS / CAMINHÕES / MÁQUINAS AGRÍCOLAS E OUTROS



Leo  
(44) 99877-2900

Carneiro  
(44) 99963-2333

(44) 3037-1126

AVENIDA PADRE THEO HERMANN, 113 - (AO LADO DO CAMPO, SAÍDA PARA AQUIDABAN - MARIALVA - PARANÁ)  
CNPJ 12.875.187/0001-56 Inscr. Est.: 90540471-74

## PRESTAÇÃO DE SERVIÇO

2164

DATA DA EMISSÃO: 10 / 05 / 19

NOME: Pref. Ma

VEÍCULO: montona

SETOR: Rod

PLACA: AVB-8126

Nº 157

2 montagem leve

2600

Preço 87

TOTAL R\$

2600

BOB CAT

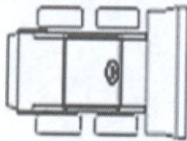

CAMINHÃO/ÔNIBUS

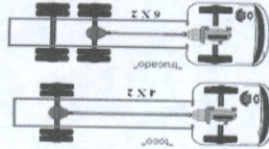

RETRO/PÁ CARREGADEIRA  
TRATOR

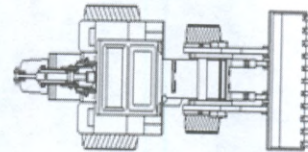

MOTO



CARRO

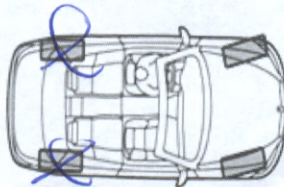

MOTONIVELADORA/PATROLA

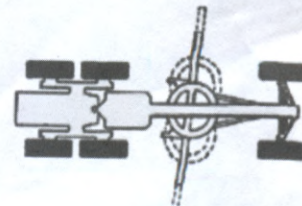

*Leandro*  
ASSINATURA CLIENTE

*[Signature]*  
ASSINATURA RESPONSÁVEL



# Borracharia do Carneiro

CONSERTO EM GERAL / PNEUS DE CARRO / MOTOCICLETAS / CAMINHÕES / MÁQUINAS AGRÍCOLAS E OUTROS



Leo  
(44) 99877-2900

Carneiro  
(44) 99963-2333

(44) 3037-1126

AVENIDA PADRE THEO HERMANN, 113 - (AO LADO DO CAMPO, SAÍDA PARA AQUIDABAN - MARIALVA - PARANÁ)  
CNPJ 12.875.187/0001-56 Inscr. Est.: 90540471-74

## PRESTAÇÃO DE SERVIÇO

2231

DATA DA EMISSÃO: 06 / 05 / 19

NOME: Prof. Maria

VEÍCULO: Caminhão

SETOR: Rod

PLACA: AY M - 361

Nº 165

1 - conserto pesado  
2 - tap top

28,00

55,00

Pagão 47

TOTAL R\$

83,00

BOB CAT

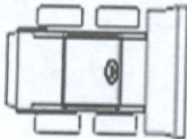

CAMINHÃO/ÔNIBUS

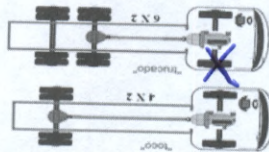

RETRO/PÁ CARREGADEIRA  
TRATOR

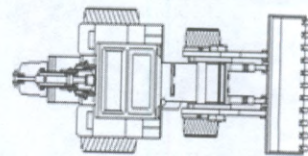

MOTO



CARRO

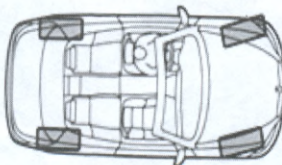

MOTONIVELADORA/PATROLA

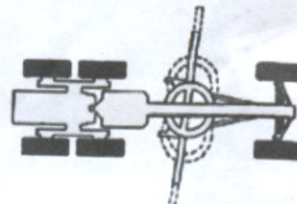

*Orlando e Filhos*  
ASSINATURA CLIENTE

*[Signature]*  
ASSINATURA RESPONSÁVEL





# Borracharia do Carneiro

CONSERVO EM GERAL / PNEUS DE CARRO / MOTOCICLETAS / CAMINHÕES / MÁQUINAS AGRÍCOLAS E OUTROS

Leo  
(44) 99877-2900

Carneiro  
(44) 99963-2333

(44) 3037-1126

AVENIDA PADRE THEO HERMANN, 113 - (AO LADO DO CAMPO, SAÍDA PARA AQUIDABAN - MARIALVA - PARANÁ)  
CNPJ 12.875.187/0001-56 Inscr. Est.: 90540471-74

## PRESTAÇÃO DE SERVIÇO

2198

DATA DA EMISSÃO: 05/05/19

NOME: Superm de Truque

VEÍCULO: 17 carregadeira

SETOR: 17 adaptativa

PLACA: 1 Carroto perado. máquina.

Nº 166

1 2000000  
1 2000000  
?

8500  
15000  
?

Pagoo 47

TOTAL R\$

23500

BOB CAT

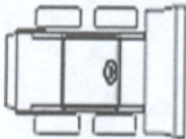

CAMINHÃO/ÔNIBUS

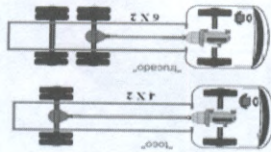

RETRO/PÁ CARREGADEIRA  
TRATOR

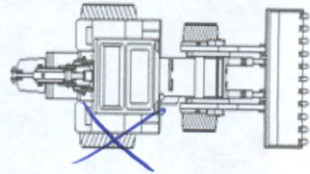

MOTO



CARRO

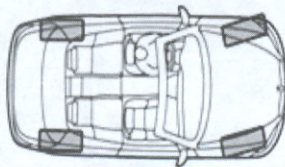

MOTONIVELADORA/PATROLA

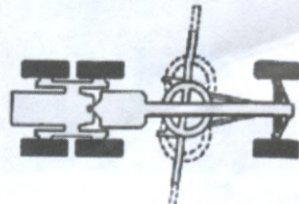

ASSINATURA CLIENTE

ASSINATURA RESPONSÁVEL

GRÁFICA AQUÁRIOS - FONES: (44) 3232-3405 - 10 BLS. - 50X2



# Borracharia do Carneiro

CONserto EM GERAL / PNEUS DE CARRO / MOTOCICLETAS / CAMINHÕES / MÁQUINAS AGRÍCOLAS E OUTROS



Leo  
(44) 99877-2900

Carneiro  
(44) 99963-2333

(44) 3037-1126

AVENIDA PADRE THEO HERMANN, 113 - (AO LADO DO CAMPO, SAÍDA PARA AQUIDABAN - MARIALVA - PARANÁ  
CNPJ 12.875.187/0001-56 Inscr. Est.: 90540471-74

## PRESTAÇÃO DE SERVIÇO

2156

DATA DA EMISSÃO:

NOME:

VEÍCULO:

PLACA:

SETOR:

Nº

09/05/19  
 Valmir Ch. Machado  
 Motoniveladora SETOR: Rodoviário  
 Conserto de Perda moq. Nº 196  
 Traucantecção 85000  
 15000

Preço 47

TOTAL R\$

23500

BOB CAT

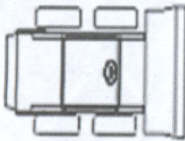

CAMINHÃO/ÔNIBUS

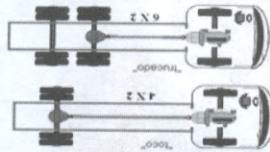

RETRO/PÁ CARREGADEIRA  
TRATOR

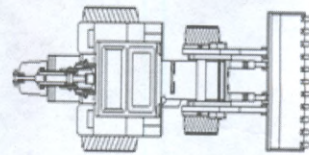

MOTO



CARRO

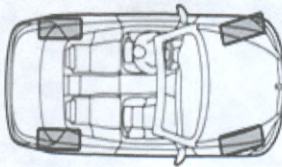

MOTONIVELADORA/PATROLA

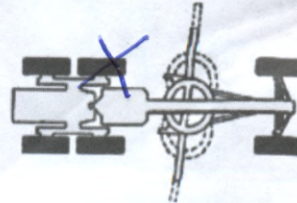

ASSINATURA CLIENTE

ASSINATURA RESPONSÁVEL

GRÁFICA AQUÁRIOS - FONES: (44) 3232-3405 - 10 BLS. - 50X2



# Borracharia do Carneiro

CONSERTO EM GERÁL / PNEUS DE CARRO / MOTOCICLETAS / CAMINHÕES / MÁQUINAS AGRÍCOLAS E OUTROS



Leo  
(44) 99877-2900

Carneiro  
(44) 99963-2333

(44) 3037-1126

AVENIDA PADRE THEO HERMANN, 113 - (AO LADO DO CAMPO, SAÍDA PARA AQUIDABAN - MARIALVA - PARANÁ  
CNPJ 12.875.187/0001-56 Inscr. Est.: 90540471-74

## PRESTAÇÃO DE SERVIÇO

2225

DATA DA EMISSÃO: 03 / 05 / 19

NOME: Pref. Maria

VEÍCULO: Caminhão

SETOR: Rod

PLACA: AVS-7027

Nº 137

1 - conserto pesado

2800

1 - Tip top

5500

Pagor 47

TOTAL R\$

8300

BOB CAT

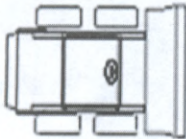

CAMINHÃO/ÔNIBUS

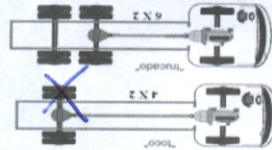

RETRO/PÁ CARREGADEIRA  
TRATOR

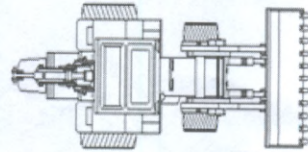

MOTO



CARRO

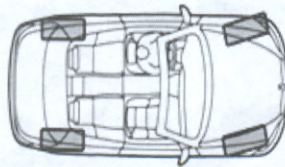

MOTONIVELADORA/PATROLA

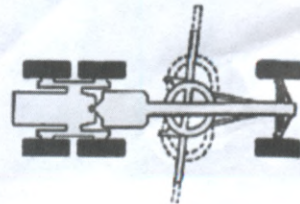

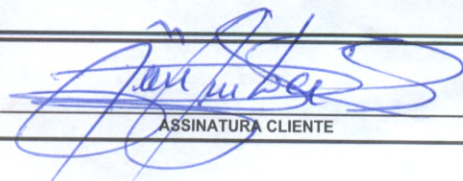

ASSINATURA CLIENTE



ASSINATURA RESPONSÁVEL

GRÁFICA AQUÁRIOS - FONES: (44) 3232-3405 - 10 BLS. - 50X2



# Borracharia do Carneiro

CONSERTO EM GERAL / PNEUS DE CARRO / MOTOCICLETAS / CAMINHÕES / MÁQUINAS AGRÍCOLAS E OUTROS



Leo  
(44) 99877-2900

Carneiro  
(44) 99963-2333

(44) 3037-1126

AVENIDA PADRE THEO HERMANN, 113 - (AO LADO DO CAMPO, SAÍDA PARA AQUIDABAN - MARIALVA - PARANÁ  
CNPJ 12.875.187/0001-56 Inscr. Est.: 90540471-74

## PRESTAÇÃO DE SERVIÇO

2218

DATA DA EMISSÃO: 02 / 05 / 19

NOME: Pref. Mar

VEÍCULO: Caminhão SETOR: Rod

PLACA: AMC-3656 Nº 25

1 montagem pesada 25,00

Pregos 47

TOTAL R\$ 25,00

BOB CAT

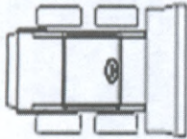

CAMINHÃO/ÔNIBUS

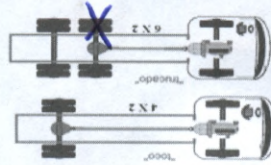

RETRO/PÁ CARREGADEIRA  
TRATOR

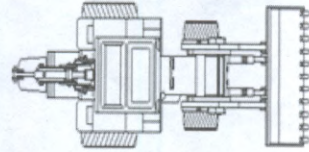

MOTO



CARRO

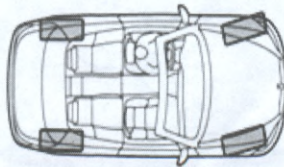

MOTONIVELADORA/PATROLA

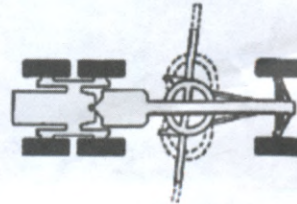

Jose Adilson Ribeiro  
ASSINATURA CLIENTE

ASSINATURA RESPONSÁVEL



# Borracharia do Carneiro

CONserto em GERAL / PNEUS DE CARRO / MOTOCICLETAS / CAMINHÕES / MÁQUINAS AGRÍCOLAS E OUTROS



Leo  
(44) 99877-2900

Carneiro  
(44) 99963-2333

(44) 3037-1126

AVENIDA PADRE THEO HERMANN, 113 - (AO LADO DO CAMPO, SAÍDA PARA AQUIDABAN - MARIALVA - PARANÁ)  
CNPJ 12.875.187/0001-56 Inscr. Est.: 90540471-74

## PRESTAÇÃO DE SERVIÇO

2215

DATA DA EMISSÃO: 02 / 05 / 19

NOME: Pref. Mza

VEÍCULO: Bob cat

SETOR: Rod

PLACA:

Nº 156

3 mont. pesado mza 21000

Pregão 47

TOTAL R\$

21000

BOB CAT

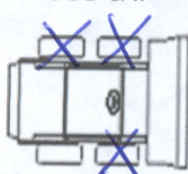

CAMINHÃO/ÔNIBUS

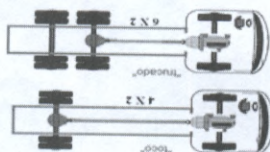

RETRO/PÁ CARREGADEIRA  
TRATOR

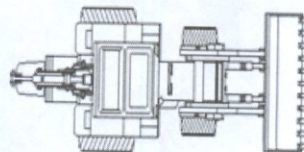

MOTO



CARRO

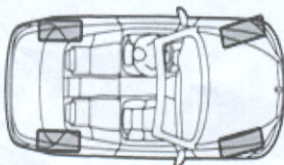

MOTONIVELADORA/PATROLA

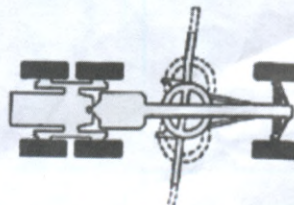

ASSINATURA CLIENTE

ASSINATURA RESPONSÁVEL



# Borracharia do Carneiro

CONSERVO EM GERAL / PNEUS DE CARRO / MOTOCICLETAS / CAMINHÕES / MÁQUINAS AGRÍCOLAS E OUTROS

Leo Carneiro  
(44) 99877-2900 (44) 99963-2333 (44) 3037-1126



AVENIDA PADRE THEO HERMANN, 113 - (AO LADO DO CAMPO, SAÍDA PARA AQUIDABAN - MARIALVA - PARANÁ)  
CNPJ 12.875.187/0001-56 Inscr. Est.: 90540471-74

## PRESTAÇÃO DE SERVIÇO

2109

DATA DA EMISSÃO: 02 / 05 / 19  
 NOME: Prof. Mma  
 VEÍCULO: Trator SETOR: Limpeza  
 PLACA: Nº 122  
 2 - conserto presso mag 17900  
 2 - tip top 11900

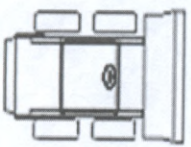
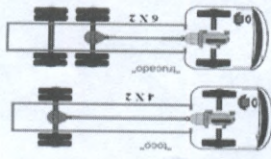
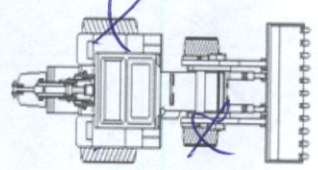
Preço 42 TOTAL R\$ 28900

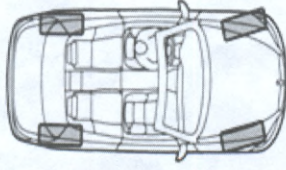
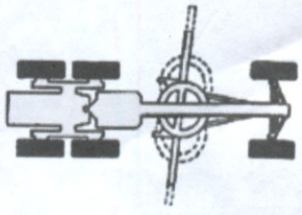
BOB CAT 	CAMINHÃO/ÔNIBUS 	RETRO/PÁ CARREGADEIRA TRATOR 
MOTO 	CARRO 	MOTONIVELADORA/PATROLA 

ASSINATURA CLIENTE \_\_\_\_\_ ASSINATURA RESPONSÁVEL \_\_\_\_\_